

TITLE 411, NEBRASKA ADMINISTRATIVE CODE, CHAPTER 4

NEBRASKA DEPARTMENT OF ROADS
TRAFFIC ENGINEERING DIVISION

RULES AND REGULATIONS CONCERNING
SPECIFIC INFORMATIONAL AND BUSINESS (LOGO) SIGNS

Title 411- NEBRASKA DEPARTMENT OF ROADS - TRAFFIC ENGINEERING DIVISION

Chapter 4 - Specific Informational and Business (Logo) Signs

Alphabetical Table of Contents

<u>Subject</u>	<u>Statutory Authority</u>	<u>Code Section</u>
Administrative	39-204, 39-205 & 39-206	008
Business (Logo) Signs	39-204, 39-205 & 39-206	007
Definitions	39-204, 39-205 & 39-206	002
Eligibility Requirements	39-204, 39-205 & 39-206	003
Exhibits A - C	39-204, 39-205 & 39-206	---
General	39-204, 39-205 & 39-206	001
Illustrations 1 - 14	39-204, 39-205 & 39-206	---
Specific Informational Signs	39-204, 39-205 & 39-206	004
Supplemental Directional Signs	39-204, 39-205 & 39-206	005
Trailblazer Signs	39-204, 39-205 & 39-206	006

Title 411- NEBRASKA DEPARTMENT OF ROADS - TRAFFIC ENGINEERING DIVISION

Chapter 4 - Specific Informational and Business (Logo) Signs

Numerical Table of Contents

<u>Subject</u>	<u>Statutory Authority</u>	<u>Code Section</u>
General	39-204, 39-205 & 39-206	001
Definitions	39-204, 39-205 & 39-206	002
Eligibility Requirements	39-204, 39-205 & 39-206	003
Specific Informational Signs	39-204, 39-205 & 39-206	004
Supplemental Directional Signs	39-204, 39-205 & 39-206	005
Trailblazer Signs	39-204, 39-205 & 39-206	006
Business (Logo) Signs	39-204, 39-205 & 39-206	007
Administrative	39-204, 39-205 & 39-206	008
Illustrations 1 - 14	39-204, 39-205 & 39-206	---
Exhibits A - C	39-204, 39-205 & 39-206	---

NEBRASKA ADMINISTRATIVE CODE

Title 411- NEBRASKA DEPARTMENT OF ROADS - TRAFFIC ENGINEERING DIVISION

Chapter 4 - Specific Informational and Business (Logo) Signs

001 GENERAL. These Rules and Regulations are set forth to adopt the requirements of Neb.Rev.Stat., §§39-204 through 39-206 and the federal requirements governing the erection and maintenance of Specific Informational and Business (Logo) signs within the right-of-way of the Interstate and primary highway systems in the State of Nebraska. The requirements set forth by the Federal Highway Administration when authorizing the installation of Specific Informational and Business (Logo) signs within the public right-of-way are to provide a service to the traveling public and not to provide an advertising medium for businesses. Limitations are placed on the number of businesses that can be identified and posted and the number of miles a motorist must travel to find the posted services. All references to Nebraska Revised Statutes refer to the most recently published Reissue or Supplement.

002 DEFINITIONS: For the purpose of these Rules and Regulations the following definitions are provided:

002.01 "Agent" shall mean a person, corporation, or business that enters into a contract with the Department of Roads for the purpose of operating the Specific Informational and Business (Logo) Sign Program.

002.02 "Annual Business Sign Fee" shall mean the fair market rental value of the sign site and any cost associated with the fabrication, erection, maintenance or servicing of Specific Informational and Business (Logo) signs.

002.03 "Business (Logo) Sign" shall mean a Type "A" sign that displays the name, brand or trademark of a qualified business or attraction, and is attached to a Specific Informational sign.

002.04 "Combination Signs" shall mean Specific Informational signs displaying availability of two types of services. Combination signs may be erected only in remote rural areas, where no more than two qualified businesses are available or will become available within two years, for each of two or more types of services.

002.05 "Department" shall mean the Nebraska Department of Roads.

002.06 "District Office" shall mean the headquarters for any one of the eight geographical subdivisions of the Nebraska Department of Roads.

002.07 "Expressway" shall mean a divided arterial highway for through traffic with full or partial control of access and generally with grade separations at intersections.

002.07A Expressways are subdivided as follows:

002.07A1 Category 1 - Expressways with at-grade intersections only.

002.07A2 Category 2 - Expressways with at-grade intersections located between interchanges on expressways.

Title 411- NEBRASKA DEPARTMENT OF ROADS - TRAFFIC ENGINEERING DIVISION

Chapter 4 - Specific Informational and Business (Logo) Signs (Continued)

002.08 "Gore" shall mean the area immediately beyond the divergence of two traveled ways, bounded by the edges of those traveled ways.

002.09 "Interstate Highway System" shall mean the National System of Interstate and Defense Highways established by the Federal Aid Highway Act of 1956, and defined in Title 23 of the United States Code.

002.10 "Lease" shall mean the written contract between the Department or the Agent and the owner or responsible operator.

002.11 "MUTCD" refers to the Manual on Uniform Traffic Control Devices and the Nebraska Supplement thereto, adopted in the Rules and Regulations, Title 411, Chapter 1, section 001, pursuant to Neb.Rev.Stat. §60-6,118, and found on Nebraska Department of Roads' website, <http://nebraskatransportation.org/traffeng/mutcd.htm>.

002.12 "Notice" shall mean notification by means of certified mail.

002.13 "Owner" shall mean the holder of fee title or the holder of a leasehold estate from the owner of real property.

002.14 "Primary Highway System" shall mean roads and streets which were designated as the Federal-Aid Primary System, as it existed on June 1, 1991, by the Department and approved by the Federal Highway Administration and which are shown on the map provided for in Neb.Rev.Stat. §39-1311. Expressways are a part of the Primary Highway System.

002.15 "Qualified Business" shall mean a business furnishing gas, food, lodging, camping or attraction, and meeting the criteria established by these Rules and Regulations.

002.16 "Responsible Operator" shall mean a person or Agent other than an owner who operates a qualified business and who has authority to enter into agreements relevant to matters covered by these Rules and Regulations.

002.17 "Rural Area" shall mean an area outside of an urban area; except that if the land within the urban area has a character that is sparsely populated, or is primarily devoted to agricultural use, or where the roadside development does not appear to be urban in character, then such land may also be considered rural. The decision of whether specific areas are rural areas under this section shall be made by the Department, and such decision shall be final.

002.18 "Specific Informational Signs" (Type B Signs) shall mean signs bearing separately affixed Business (Logo) signs.

002.19 "Supplemental Directional Signs" (Type B Signs) shall mean Specific Informational signs bearing separately affixed Business (Logo) signs located adjacent to an exit ramp.

Title 411- NEBRASKA DEPARTMENT OF ROADS - TRAFFIC ENGINEERING DIVISION

Chapter 4 - Specific Informational and Business (Logo) Signs (Continued)

002.20 "Serve at least two meals per day" shall mean that the business shall be open to the public not later than 10:30 a.m. and shall serve, as a minimum, a breakfast and lunch, or a lunch and dinner.

002.21 "Trailblazer Signs" (Type A Signs) shall mean Business (Logo) signs located along the route leading from the Interstate or Primary Highway to qualified businesses.

002.22 "Traveled Way" shall mean the through traffic lanes of the Interstate or Primary Highway System and shall include exit, entrance ramps and acceleration, deceleration lanes.

002.23 "Urban Area" shall mean the developed area inside and outside the corporate limits of municipalities with a population of 5,000 or more as shown on the urban area maps on file with the Department of Roads.

002.24 "Visible," as used in Neb.Rev.Stat. §§39-215, 39-216 and 39-220 in reference to advertising signs, displays, or devices, shall mean the message or advertising content of such sign, display, or device is capable of being seen without visual aid by a person of normal visual acuity. A sign shall be considered visible even though the message or advertising content may be seen but not read.

003 ELIGIBILITY REQUIREMENTS

003.01 The eligibility requirements are applicable to all Type A and Type B Signs erected.

003.02 Qualified businesses must provide the Department or the Agent with a written assurance of conformity with all Federal and State laws concerning the provisions of public accommodations without regard to race, religion, color, age, sex or national origin, and laws concerning the licensing and approval of service facilities.

003.03 Any facility that provides gas, food, lodging, camping or is an attraction that has erected an advertising sign that does not comply with the requirements of Neb.Rev.Stat. §§39-213 through 39-226 and the Rules and Regulations, Title 410, Chapter 3, Section 002, Control of Advertising in Areas Adjacent to the Highway Beautification Control System, shall not be eligible to be identified on any of the Business (Logo) signs until all illegal signs are removed or brought into conformity with the law.

003.04 SERVICES PROVIDED - In order to be a qualified business, the business must provide one or more of the following services: gas, food, lodging, camping or attraction.

003.04A Such business must also meet the following criteria:

003.04A1 Gas-diesel vehicle service stations shall:

003.04A1a Provide fuel, oil and water.

Title 411- NEBRASKA DEPARTMENT OF ROADS - TRAFFIC ENGINEERING DIVISION

Chapter 4 - Specific Informational and Business (Logo) Signs (Continued)

003.04A1b Provide modern restroom facilities and drinking water.

003.04A1c Provide a telephone available for public use.

003.04A1d Be in continuous operation at least 16 hours per day, seven days per week, on the Interstate or freeway; and at least 12 hours per day, seven days per week, on Primary Highways.

003.04A2 Food and restaurant facilities shall:

003.04A2a Be approved and/or licensed by the State Agency or political entity having jurisdiction.

003.04A2b Be in continuous operation to serve at least two meals per day, at least six days per week.

003.04A2c Provide modern restroom facilities.

003.04A2d Provide a telephone available for public use.

003.04A3 Lodging, motel and hotel facilities shall:

003.04A3a Be approved and/or licensed by the State Agency or political entity having jurisdiction.

003.04A3b Provide a telephone available for public use.

003.04A3c Provide adequate sleeping accommodations.

003.04A3d Provide modern restroom facilities.

003.04A4 Camping and campground facilities shall:

003.04A4a Be approved and/or licensed by the State Agency or the political entity having jurisdiction.

003.04A4b Provide modern restroom facilities and drinking water.

003.04A4c Provide adequate camping and parking spaces.

003.04A4d Business signs for campgrounds operated on a seasonal basis will be covered or removed during the off season.

Title 411- NEBRASKA DEPARTMENT OF ROADS - TRAFFIC ENGINEERING DIVISION

Chapter 4 - Specific Informational and Business (Logo) Signs (Continued)

003.04A5 Attraction services shall:

003.04A5a Be of regional significance with the primary purpose of providing amusement, historical, cultural or leisure activity to the public.

003.04A5b Provide adequate parking accommodations.

003.04A5c Provide modern restroom facilities and drinking water.

003.04A5d Be open to the public at least 40 hours per week, at least five days a week, one of which must be a Saturday or a Sunday, for the normal operating season for the type of business. Exceptions: (1) This requirement shall not apply to certain facilities such as: arenas, stadiums, amphitheaters or race tracks. (2) A winery or brewery shall be open at least 20 hours per week; the week must include a Saturday or a Sunday.

003.04A5e Be appropriately licensed as required by law, where required.

003.04A5f Be approved by the State Historical Society, where required.

003.04A6 The attraction must be one of the following types of facilities: (1) area of natural beauty or phenomena, (2) historical site, (3) cultural site or museum, (4) scientific site, (5) recreational site or facility, or (6) golf course.

003.04A7 Business signs for attractions operated on a seasonal basis will be covered or removed during the off season.

003.05 LOCATION OF THE BUSINESS

003.05A Specific Informational signs shall be erected only for qualified businesses located within three miles of the interchange, or intersection, as the case may be, as measured from the gore of the exit ramp, right-turning lane, or intersection, to the nearest point of intersection of the driveway of the qualified business and public highway, except as provided in Sections 003.05B through 003.05F.

003.05B If no qualified business of a specific type exists, or participates in this program, within three miles of the interchange, or intersection, then successive three-mile increments may be considered. If considered, then all qualified businesses within the successive increment may be included, but not to exceed the maximum capacity of the individual service sign.

003.05C Gas, food and lodging services located more than six miles from the interchange, or intersection, shall not be eligible for posting.

Title 411- NEBRASKA DEPARTMENT OF ROADS - TRAFFIC ENGINEERING DIVISION

Chapter 4 - Specific Informational and Business (Logo) Signs (Continued)

003.05D Camping services located more than 15 miles from the interchange, or intersection, shall not be eligible for posting.

003.05E Attraction services located more than 15 miles from the interchange, or intersection, shall not be eligible for posting.

003.05F A qualified business (other than attractions) located more than three miles from an interchange, or intersection, shall not qualify for posting if a motorist could obtain similar services adjacent to the next interchange or intersection, by traveling fewer miles.

004 SPECIFIC INFORMATIONAL SIGNS

004.01 LOCATION

004.01A Specific Informational signs on the Interstate and Category 2 Expressway shall be erected not less than 800 feet in advance of the exit direction sign at the interchanges or intersections.

004.01B The exact location of Specific Informational signs and Supplemental Directional signs shall be approved by the Department; however, such signs shall be located so as to have the least impact on the scenic environment, and to avoid conflict with other signs within the highway right-of-way. Lateral clearance and height shall be as specified in the MUTCD and Exhibit C of these Rules and Regulations.

004.01C Specific Informational signs on the Primary Highway System, including Category 1 Expressways, shall be erected not less than 300 feet in advance of the edge of the traveled way of the intersecting road or street, or in advance of the gore of the right-turning lane.

004.01D Spacing between each Specific Informational sign shall be not less than 800 feet, or more than 1,000 feet, on the Interstate and Primary Highway System.

004.01E Specific Informational signs shall be displayed as designated in the MUTCD and these Rules and Regulations.

004.01F Specific Informational signs shall not be erected at an interchange where an exit ramp is provided but no convenient re-entry ramp exists in the same direction of travel.

004.01G Specific Informational signs shall not be erected on interchanges where the interchange ramps connect directly to another Interstate highway or freeway.

Title 411- NEBRASKA DEPARTMENT OF ROADS - TRAFFIC ENGINEERING DIVISION

Chapter 4 - Specific Informational and Business (Logo) Signs (Continued)

004.01H Specific Informational signs shall not be erected in an urban area where interchanges are located two miles or less apart or where the traveler could reasonably expect to find food, fuel, and lodging when leaving the Interstate or Primary Highway System.

004.01I The number of Specific Informational signs along an approach to an interchange or intersection, regardless of the number of service types displayed, shall be limited to a maximum of four.

004.01J Specific Informational signs shall be installed in the direction of traffic in this order, attraction, camping, lodging, food and gas.

004.01K No more than three types of services shall be represented on any sign or sign assembly. If three types of services are displayed on one sign, then the Logo sign panels shall be limited to two for each service type.

004.02 SIGN DESIGN

004.02A Specific Informational Signs shall be constructed using Type B extruded sign panels. Exit number shall be displayed at numbered interchanges in place of the directional legend (i.e., "Next Right," etc.). Sign designs shall be in compliance with the MUTCD.

004.02B Sign Material (Type "B" Signs)

004.02B1 Specific Informational signs shall be constructed of extrusheet, aluminum horizontally joined panels, called Type "B" Signs (Exhibit B). They shall have reflective blue background sheeting, in accordance with the MUTCD, the Nebraska Department of Roads Standard Specifications for Highway Construction, and these Rules and Regulations including tables, illustrations and exhibits.

004.02B2 The reflective background sheeting shall be Type IV sheeting conforming to ASTM Designation: D 4956-09.

004.02B3 The reflective sheeting used for legends shall be Type IV, VII or XI with ASTM Designation: D 4956-09.

004.02B4 Higher reflective grade sheeting may be used for background or legend when approved by the Traffic Engineer.

004.02B5 Existing Specific Informational signs sheeted with Type III sheeting for background or legend may remain in place for the rest of its useful life.

Title 411- NEBRASKA DEPARTMENT OF ROADS - TRAFFIC ENGINEERING DIVISION

Chapter 4 - Specific Informational and Business (Logo) Signs (Continued)

004.02C Structural Supports

004.02C1 Signs shall be mounted on structural steel beam breakaway posts fabricated and installed in accordance with the latest edition of the Nebraska Department of Roads Standard Specifications for Highway Construction and Exhibit C.

004.02C2 Footings shall be as required in the latest edition of the Nebraska Department of Roads Standard Specifications for Highway Construction and Exhibit C.

005 SUPPLEMENTAL DIRECTIONAL SIGNS

005.01 The information displayed on Specific Informational signs must be repeated on Supplemental Directional signs when the qualified businesses identified on the Specific Informational signs are not visible by traffic approaching from either the traveled way of the Interstate Highway System, from an interchange ramp, or from a highway intersection.

005.02 The Department shall determine if a qualified business is visible from either the traveled way of the Interstate Highway System, from an interchange ramp, or from a highway intersection.

005.03 LOCATION

005.03A Supplemental Directional signs shall be located on the highway right-of-way along the interchange ramp or at the ramp terminal, or along the intersecting highway.

005.03B The exact location of the Supplemental Directional signs shall be determined by the Department.

005.04 SPACING - A minimum of 100 feet is required between successive Supplemental Directional signs.

005.05 ORDER OF DISPLAY - Supplemental Directional signs shall be installed in the same order as the Specific Informational signs.

005.06 DESIGN

005.06A Specifications – Supplemental Directional Signs shall conform to the MUTCD.

005.06B Sign Material - Supplemental Directional signs shall be constructed of the same material required for Specific Informational signs in accordance with these Rules and Regulations including tables, illustrations, and exhibits.

Title 411- NEBRASKA DEPARTMENT OF ROADS - TRAFFIC ENGINEERING DIVISION

Chapter 4 - Specific Informational and Business (Logo) Signs (Continued)

005.06C Structural Supports

005.06C1 Supplemental Directional signs shall be mounted on structural steel beam breakaway posts fabricated and installed in accordance with the latest edition of the Nebraska Department of Roads Standard Specifications for Highway Construction and Exhibit C.

006 TRAILBLAZER SIGNS

006.01 Trailblazer signs, also called Type "A" signs, may be installed along the highway for qualifying businesses, only if the business cannot be seen from the highway.

006.02 LOCATION

006.02A Trailblazer signs may be located on the right-of-way of the public highway at all intersections where the direction of the route changes or where it might be questionable as to which roadway to follow.

006.02B If conflicts with existing signs should arise, then the exact location of Trailblazer signs shall be determined by the Department. (See Illustration 13).

006.03 ORDER OF DISPLAY - Trailblazer signs shall be erected in the same order as Specific Informational signs.

006.04 DESIGN

006.04A Trailblazer signs shall conform to the design requirements established by these Rules and Regulations.

006.04B Trailblazer signs shall indicate, by arrow, the direction to the qualified business.

006.05 STRUCTURAL SUPPORTS - Trailblazer signs shall be erected on steel or wood posts, which conform to the requirements of Type "A" Signs, as shown in Illustration 13, and Exhibit A.

007 BUSINESS (LOGO) SIGNS

007.01 COPY

007.01A Only a business name, brand name, trademark, Logo, commercial symbol, or combination of these shall be used. If a nationally, regionally or locally recognized commercial symbol, Logo or trademark is available, it shall be used in preference to any other form of business identification.

Title 411- NEBRASKA DEPARTMENT OF ROADS - TRAFFIC ENGINEERING DIVISION

Chapter 4 - Specific Informational and Business (Logo) Signs (Continued)

007.01B Any message which advertises rather than identifies a business is prohibited. On "GAS" business signs, the word "diesel," "E85," and/or a Department approved symbol for liquified petroleum fuel, or a Department approved symbol for diesel, ethanol or other approved alternative fuel symbol may be included on the business sign.

007.01C Messages, logos, symbols, or trademarks which interfere with, imitate, or resemble any official warning or regulatory signs, signals or traffic control devices, or attempt or appear to attempt to direct the movement of traffic are prohibited.

007.01D A Business (Logo) sign panel shall not display the symbol/trademark or name of more than one business.

007.02 DESIGN SPECIFICATIONS

007.02A Size

007.02A1 Sign sizes, including the border, if any, shall be as specified in the MUTCD and these Rules and Regulations. The corners of the sign shall be trimmed to conform to the required radius as shown in Illustration 12. All edges shall be smooth and free of burrs.

007.02B Color, Size of Figures and Legend

007.02B1 The Business (Logo) sign shall have a white message on a blue background. Colors consistent with customary use may be used with nationally, regionally, or locally known symbols or trademarks. The principal legend on the Business (Logo) sign shall be a minimum of eight inches in height. Where a symbol or trademark is used alone for the Business sign, any legend on the symbol or trademarks shall be in proportion to the size. The Business (Logo) signs shall have a white border. When symbols or trademarks are used alone, the border may be omitted. (See Illustrations 10 and 11)

007.02C Material

007.02C1 The sign shall be fabricated from a single sheet of minimum thickness 0.063 aluminum of alloys 6061-T6 or 5052-H38. The aluminum shall be treated before applying the reflective sheeting in accordance with the reflective sheeting manufacturer's specifications. (Illustration 12)

007.02C2 Minimum reflective intensity for manufactured colors, after sign fabrication, shall conform to the requirements of the Standard Specification for Retroreflective Sheeting for Traffic Control, ASTM Designation: D 4956-09. All reflective sheeting for Type A and B signs shall be Type IV sheeting. All sheeting shall be applied with mechanical equipment in accordance with the manufacturer's specifications.

Title 411- NEBRASKA DEPARTMENT OF ROADS - TRAFFIC ENGINEERING DIVISION

Chapter 4 - Specific Informational and Business (Logo) Signs (Continued)

007.02C3 Higher reflective grade sheeting may be used for background or legend when approved by the Traffic Engineer.

007.02D Mounting

007.02D1 Sign Arrangement - Business (Logo) signs shall be placed on a Specific Informational sign, having two rows of such signs in order of increasing distance as follows:

Closest, upper left; second, lower left; third, upper center; fourth, lower center; fifth, upper right; sixth, lower right. On Specific Informational signs with a single row of business signs, individual business signs shall be placed in order of increasing distance from left to right. Relative distance of each qualified business to the interchange shall be determined at the time of lease application. (See Illustrations 1 and 2)

007.02D2 The order of arrangement for Business (Logo) signs on Supplemental Directional signs and Trailblazer signs will be determined by the direction of the arrow. Businesses located on the left shall be designated at the top of the sign as shown in Illustrations 8 and 13.

007.02E Supplemental message

007.02E1 A portion of the Logo may be used to display a supplemental message horizontally along the bottom of the Business (Logo) sign panel, provided that the message displays essential motorist information.

007.02E2 Any supplemental message shall be displayed within the Logo sign panel and have letters and numerals that comply with Table 007.

007.02E3 No more than one supplemental message may be displayed on a Logo panel.

007.02E4 The supplemental message should be displayed in a color to contrast effectively with the background of the Business (Logo) panel, typical colors will be a black legend on yellow background.

007.02E5 Typical supplemental messages may include "DIESEL," "E85," "24 HOURS," "OPEN with days of week," "CLOSED with day or days of week," "ALTERNATIVE FUELS" and "RV ACCESS." (See Illustration 3b). If the RV ACCESS supplemental message is circular, it shall be the abbreviation "RV" in black letters on a yellow circle with black background. (See Illustration 3b).

Chapter 4 - Specific Informational and Business (Logo) Signs (Continued)

Table 007 Minimum Letter and Numeral Sizes for Specific Service Signs by Sign Type (inches)		
Specific Service Signs	Freeway/Interstate	Nebraska Expressway/ Conventional Road or Ramp
• Service Categories	10	6
• Exit Number Words	10	–
• Exit Number Numerals/Letters	10	–
• Action Message Words	10	6
• Distance Numerals	–	6
• Distance Fraction Numerals	–	4
Logo Sign Panels	60x36 or 48x36	30x18 or 24x18
Words/Numerals (<i>Non-Trademark/Graphic Logo</i>)	8	4
Trademark/Graphic Logo	Proportional	Proportional
Supplemental Message Word/Numerals	5	2.5

008 ADMINISTRATIVE. The Department or the Agent shall give one public notice of intent to erect Specific Informational sign panels at an interchange or intersection 90 days prior to accepting requests to place Business (Logo) signs on the panels. Said notice of intent shall be published in a legal newspaper of the county or counties where the signs will be erected. Said notice shall specify from whom applications may be requested, and where or to whom said applications must be submitted for consideration.

008.01 APPLICATION

008.01A Requests for space on the informational sign panels may be submitted to the Department or the Agent.

008.01B All requests must be made by the owner or authorized representative of a qualified business.

008.01C Each Specific Informational sign or sign assembly shall be limited to no more than six Business (Logo) panels. (See Illustration 3)

Title 411- NEBRASKA DEPARTMENT OF ROADS - TRAFFIC ENGINEERING DIVISION

Chapter 4 - Specific Informational and Business (Logo) Signs (Continued)

008.01D Where more than six businesses of a specific service type are eligible for Logo sign panels at the same interchange, additional Logo panels of that same specific service type may also be displayed in accordance below:

008.01D1 No more than 12 Business (Logo) sign panels of a specific service type shall be displayed on no more than two specific service signs or sign assemblies.

008.01D2 No more than six logo sign panels shall be displayed on a single specific service sign.

008.01D3 No more than four Specific Informational sign panels shall be displayed on any approach.

008.01E In the event that the requests to place Business (Logo) signs on informational sign panels exceeds the available space, the following criteria shall be used to determine the allocation of spaces on informational sign panels.

008.01E1 In all instances, those businesses nearest to the interchange or intersection will be given priority. "Nearest," or "closer," as used herein, shall be determined as previously described in Sections 003, 003.05 and 003.05A.

008.01E2 The first six applications received from qualified applicants for fuel, food, lodging, camping and attraction shall be selected to place their logo on the informational sign if said applicants meet the minimum criteria set forth in these regulations. The applications may be received by either the Agent or the Department headquarters in Lincoln, Nebraska, whichever is designated in the public notice required in Section 008.

008.01E3 Once the maximum number of similar type businesses are posted on the informational sign panels at an interchange or intersection, other similar type businesses closer to the interchange or intersection shall have priority over the first applicant. The first applicant shall have the right to occupy his or her space for one year from the date of installation or rental period.

008.01E4 If Trailblazer signs are required for a qualified business, they shall be installed at the same time or prior to installing the Business (Logo) sign on the Specific Informational sign panels. The Department or the Agent shall determine if Trailblazer signs are necessary.

Title 411- NEBRASKA DEPARTMENT OF ROADS - TRAFFIC ENGINEERING DIVISION

Chapter 4 - Specific Informational and Business (Logo) Signs (Continued)

008.02 MAINTENANCE

008.02A The Department or the Agent shall repair or replace within four weeks after damage occurs, any informational sign panels that are destroyed or damaged by act of God or vehicle accident.

008.02B The Agent shall be responsible for washing all informational sign panels and Business (Logo) signs on an annual basis or at any time the reflectorized facing becomes dull.

008.02C The Agent shall be responsible for conducting an inspection annually on the breakaway mechanism for any dirt or other obstruction that may interfere with the breakaway mechanism. All bolts shall be loosened and retorqued to proper specification.

008.02D The Agent shall be responsible for the cost of the relocation of Specific Informational sign panels for highway improvements and shall complete the relocation within 60 days after notification that the sign must be removed.

008.02E Specific Informational signs, Supplemental Directional signs and Trailblazer signs which no longer display any business logo shall be taken down (sign and posts) if vacant for greater than 180 days. Exception will be provided for camping and attraction signs that are vacant or covered for seasonal closures.

008.03 REMOVAL OF BUSINESS SIGNS AND COVERING SEASONAL SIGNS

008.03A The owner of any business sign must be notified by certified mail a minimum of 30 days in advance of the removal of his or her sign for any cause.

008.03B Business (Logo) signs may be removed for any of the following:

008.03B1 Failure to pay rental fee.

008.03B2 Owning signs that are in conflict with the Rules and Regulations, Title 410, Chapter 3, Section 002, Control of Advertising in Areas Adjacent to the Highway Beautification Control System.

008.03B3 Failure to meet the minimum requirements for each type of business sign set forth in the state statutes, these regulations, and as provided under Section 008.01E.

008.03B4 Repeated delinquency as to any of the aforesaid violations.

008.03C If a business is closed due to fire, accident, remodeling or other emergencies for more than seven, but not more than 90 days, then the Agent shall have the Business (Logo) sign covered to prevent inconveniencing the traveling public. The business shall not lose its priority or be required to reapply prior to the normal expiration of its contract. Extensions of time beyond 90 days may be granted in such case where insurance claims or financial arrangements require additional time. However, an

Title 411- NEBRASKA DEPARTMENT OF ROADS - TRAFFIC ENGINEERING DIVISION

Chapter 4 - Specific Informational and Business (Logo) Signs (Continued)

owner who, due to his or her own negligence, fails to open within the 90-day period may lose his or her right to occupy the informational sign panel.

008.03D The Agent shall be responsible for covering, or removing and subsequently reinstalling, the Business (Logo) sign for a campground or attraction, if the facility is closed during the winter months.

008.04 MOTORIST SERVICE SIGNS AT INTERSTATE INTERCHANGES

008.04A At interchanges on the Interstate System where none of the qualified businesses wish to participate in the program, the Department will maintain the existing motorist service signs.

008.04B The motorist service signs at any interchange will be removed by the Department when the first Specific Informational sign panel is installed. An exception will be considered for camping motorist service signs to remain in place.

008.05 SUPPLEMENTAL DESIGNATION SIGNS AT INTERCHANGES

008.05A At interchanges where a facility chooses to participate with a Specific Informational Business (Logo) attraction sign, any existing supplemental sign for the same facility will be removed by the Department.

008.05B If a once removed facility discontinues the Specific Informational Business (Logo) program and requests to be re-installed on the Supplemental Designation sign, it must reapply and compete with other facilities for available space on the sign. A facility that was once removed and reappplies within 10 years may be required to pay for the refabrication of a new sign.

008.06 FEES FOR POSTING ON SPECIFIC INFORMATIONAL SIGN PANELS. The fee for placing Business (Logo) signs on Specific Informational sign panels shall include, but not be limited to: the fair market rental value of the sign site; fabrication, erection, maintenance or servicing of Specific Informational and Business (Logo) signs; removal or covering Business (Logo) signs; other costs associated with the program, and when applicable, reasonable profit for the Agent operating the program. The fee shall include the Supplemental Directional sign if needed. An additional fee will be charged for Trailblazer signs if needed. The fee for each space on the Specific Informational sign panel shall be the same to all businesses, except that in the category of camping and attraction, the annual fee paid by the business may be reduced by the ratio that the number of full or partial months that the facility is closed to public usage bears to the number of months in a year, but the resulting fee shall be not less than 50 percent of the annual fee. The lease agreement shall be for a term of not less than one year, nor more than five years. It shall specify the cost of Trailblazer signs and the covering of seasonal signs and other information that is necessary. Leases shall be paid annually in full in advance.

008.07 OVERSIGHT OF THE AGENT BY THE DEPARTMENT. The Department may review all proposed locations for Specific Informational sign panels to determine if there is a conflict with existing signs or future

Title 411- NEBRASKA DEPARTMENT OF ROADS - TRAFFIC ENGINEERING DIVISION

Chapter 4 - Specific Informational and Business (Logo) Signs (Continued)

sign installations. The Department may make spot checks of the leases with the applicant, check businesses for compliance with state statutes and these regulations, and make such audits as may be necessary to determine that the program is operated equitably with the qualified businesses and the Department.

ANNOTATION

Title 411
Chapter 4

Enabling Legislation
39-204, 39-205 and 39-206
Neb. Rev. Stat.

TYPICAL SIGNING FOR SINGLE EXIT INTERCHANGE

Illustration 1

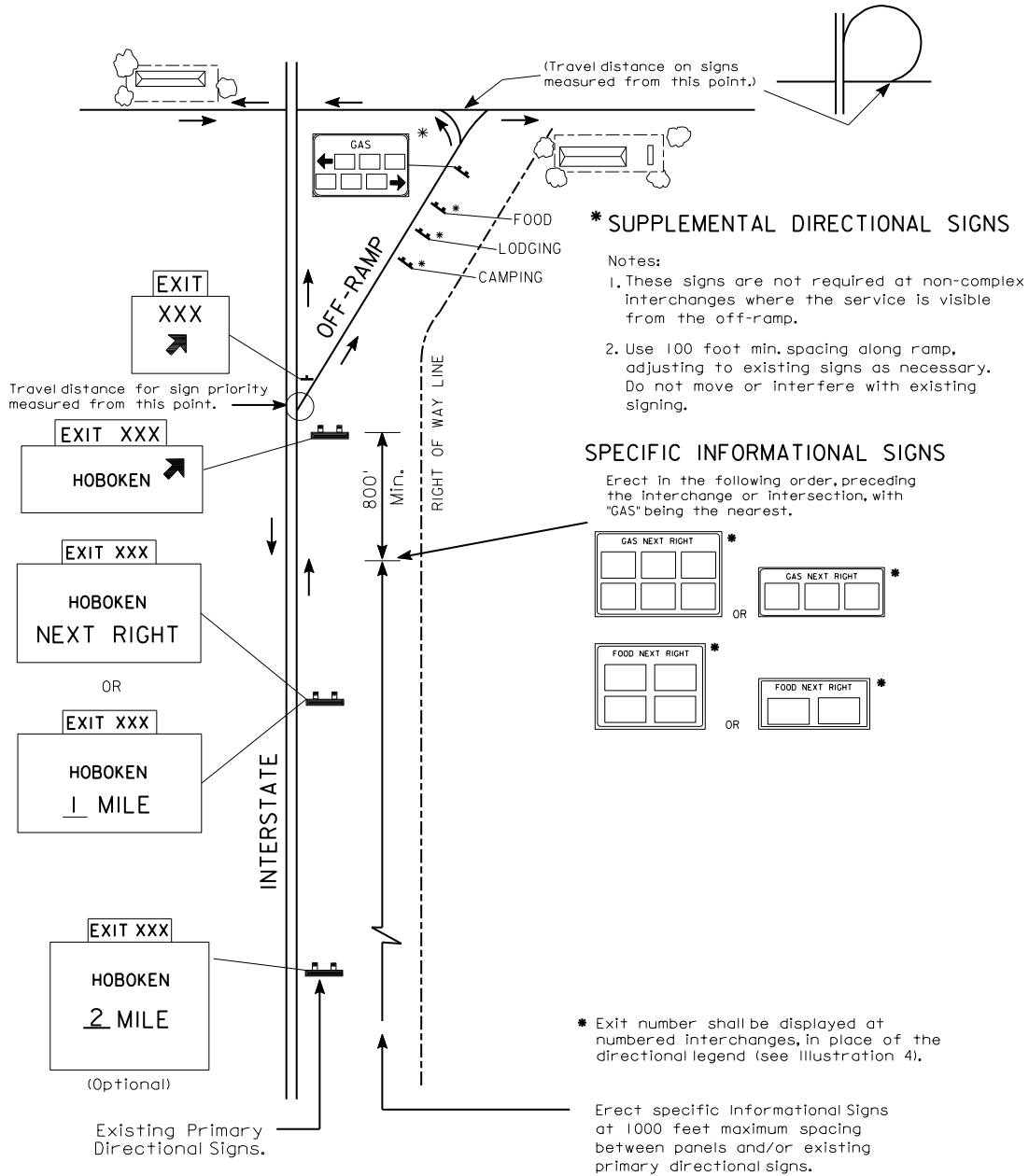

TYPICAL SIGNING FOR DOUBLE EXIT INTERCHANGE

Illustration 2

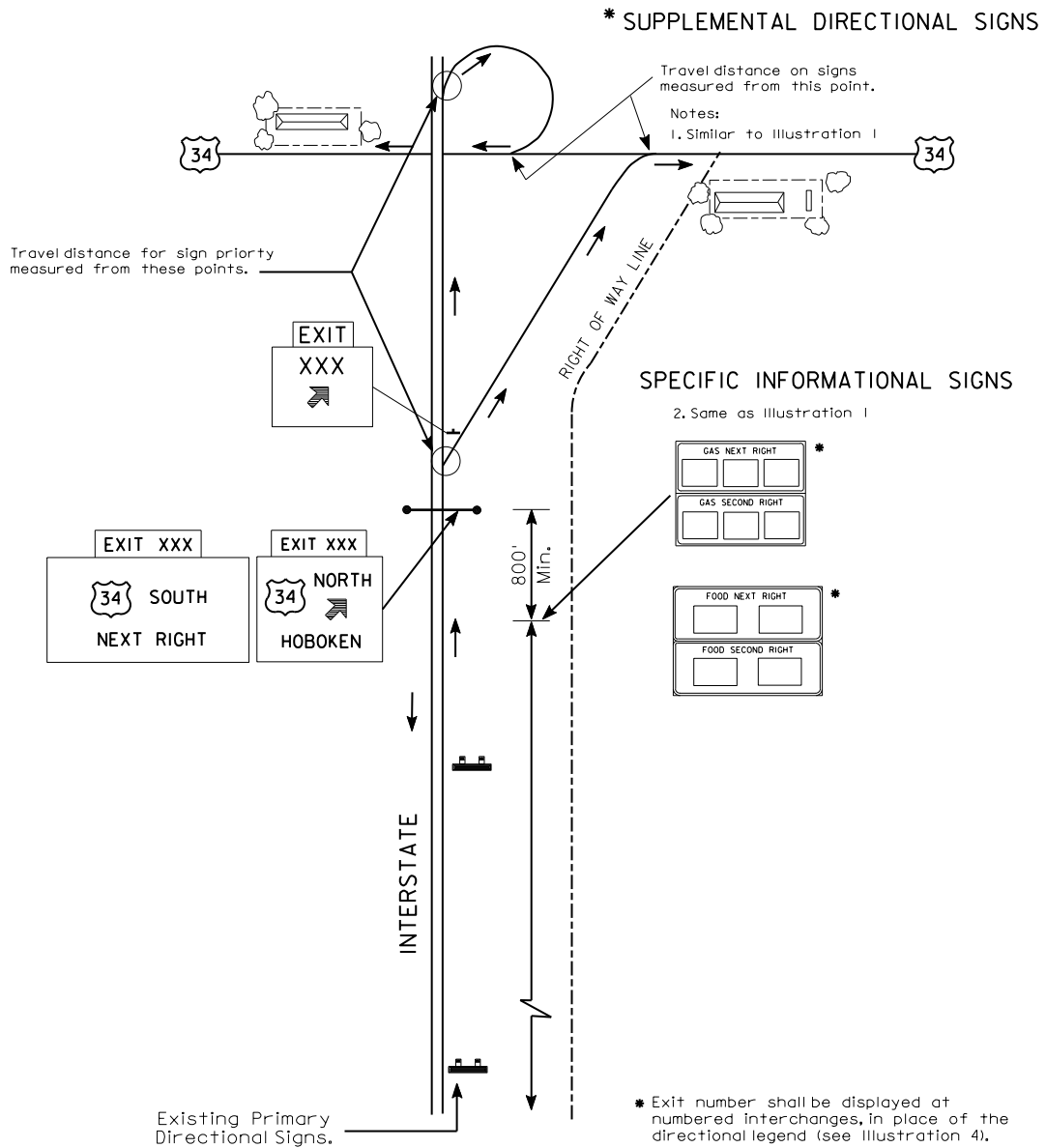

Chapter 4 - Specific Informational and Business (Logo) Signs (Continued)

Illustration 3

Single Exit Interchange (One Service) - White on Blue

A



UP TO 6 BUSINESS LOGOS

A-1



UP TO 4 BUSINESS LOGOS

A-2



UP TO 3 BUSINESS LOGOS

A-3



UP TO 2 BUSINESS LOGOS

Single Exit Interchange (Two Services) - White on Blue

B



UP TO 6 BUSINESS LOGOS
(3 OF EACH TYPE)

B-1

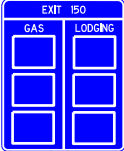

UP TO 6 BUSINESS LOGOS
(3 OF EACH TYPE)

B-2

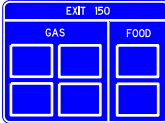

UP TO 6 BUSINESS LOGOS
(4 OF 1ST, 2 OF 2ND TYPE)

B-3



UP TO 6 BUSINESS LOGOS
(2 OF 1ST, 4 OF 2ND TYPE)

B-4



UP TO 3 BUSINESS LOGOS

Single Exit Interchange (Three Services) - White on Blue

C

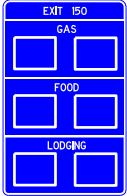

UP TO 6 BUSINESS LOGOS
(2 OF EACH TYPE)

C-1

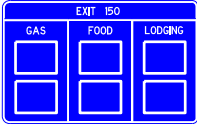

UP TO 6 BUSINESS LOGOS
(2 OF EACH TYPE)

C-2

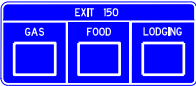

UP TO 3 BUSINESS LOGOS
(1 OF EACH TYPE)

Double Exit Interchange (One or Two Services) - White on Blue

D

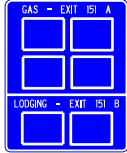

UP TO 6 BUSINESS LOGOS
(4 FOR 1ST, 2 FOR 2ND EXIT)

D-1

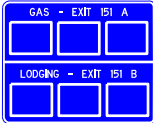

UP TO 6 BUSINESS LOGOS
(3 FOR EACH EXIT)

D-2

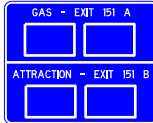





UP TO 4 BUSINESS LOGOS
(2 FOR EACH EXIT)

Title 411- NEBRASKA DEPARTMENT OF ROADS - TRAFFIC ENGINEERING DIVISION



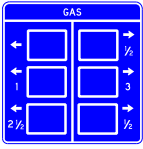
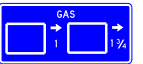
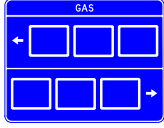

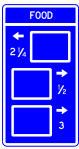
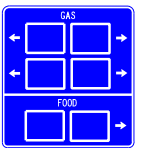
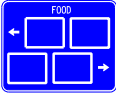
Chapter 4 - Specific Informational and Business (Logo) Signs (Continued)

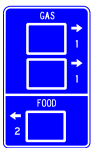
Illustration 3a

Ramp (One or Two Service) - White on Blue

<p>E</p>  <p>UP TO 6 BUSINESS LOGOS</p> <p>E-5</p>  <p>UP TO 2 BUSINESS LOGOS</p>	<p>E-1</p>  <p>UP TO 6 BUSINESS LOGOS</p> <p>E-6</p>  <p>1 BUSINESS LOGO</p>	<p>E-2</p>  <p>UP TO 3 BUSINESS LOGOS</p> <p>E-7</p>  <p>UP TO 6 BUSINESS LOGOS (4 FOR 1ST, 2 FOR 2ND TYPE)</p>	<p>E-3</p>  <p>UP TO 4 BUSINESS LOGOS</p>	<p>E-4</p>  <p>UP TO 2 BUSINESS LOGOS</p> <p>E-8</p>  <p>UP TO 3 BUSINESS LOGOS (2 FOR 1ST, 1 FOR 2ND TYPE)</p>
---	--	---	---	---

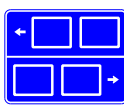
Intersection - White on Blue

<p>F</p>  <p>UP TO 4 BUSINESS</p>	<p>F-1</p>  <p>UP TO 4 BUSINESS 2 OF EACH TYPE</p>	<p>F-2</p>  <p>UP TO 4 BUSINESS 2 EACH DIRECTION</p>	<p>F-3</p>  <p>1 BUSINESS LOGO</p>
--	---	---	---

Exit Number Plaque - White on Blue



Logo Sign Panel - White on Blue

H



<u>MAINLINE</u>	<u>RAMP</u>
48" X 30" or 60" X 36"	24" X 18" or 30" X 18"

Chapter 4 - Specific Informational and Business (Logo) Signs (Continued)

Illustration 3b

Logo Sign Panels with Supplemental Messages - White on Blue, White on Green, White on Brown, Black on Yellow
Figure 2J-3



Logo Sign Panels with Supplemental Messages for RV Access - White on Brown, Black on Yellow
Figure 2J-3



* SEE ILLUSTRATIONS 4 THROUGH 8 FOR ADDITIONAL INFORMATION ON PANELS.

SPECIFIC INFORMATIONAL SIGN SIZES
(SINGLE EXIT INTERCHANGE)

Illustration 4

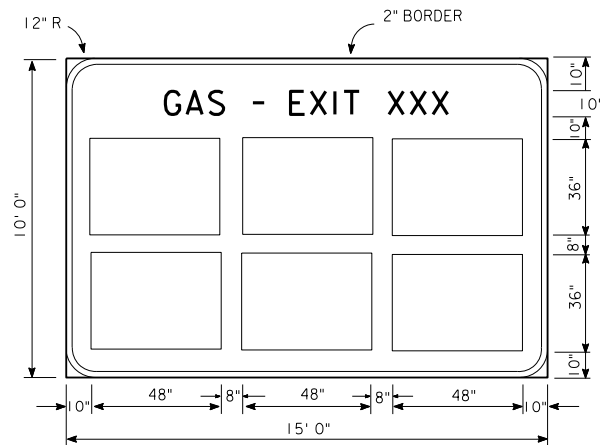

PANEL A

Sign Details

- Panel Color - Reflective blue
- Message - 10" reflective white capital letters
- Border - Reflective white

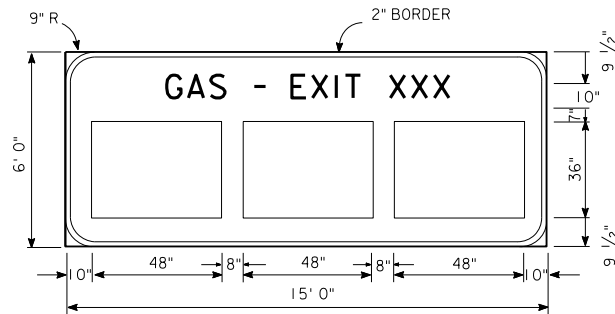

PANEL A-1

- NOTES:
1. Panel A is intended for usage where there are at least 3 qualified services and the possibility for more.
 2. Panel A-1 may be used where there are only 1 or 2 qualified services and it is not likely that there will be more than 3.
 3. All reflective sheeting shall be ASTM D4956 Type IV or greater.
 4. Directional legend shall be used at unnumbered interchanges or intersections, in place of exit number (see illustration 5).
 5. Gas, food, lodging, camping, and attraction specific information signs may conform to specified sizes for panels A and A-1 where warranted.

SPECIFIC INFORMATIONAL SIGN SIZES

(SINGLE EXIT INTERCHANGE)

Illustration 5

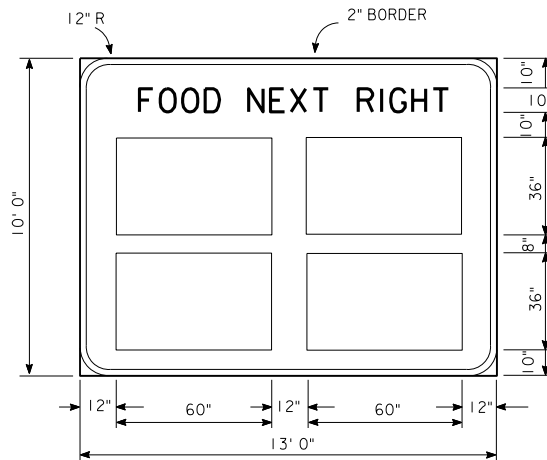

PANEL B

Sign Details

- Panel Color - Reflective blue
- Message - 10" reflective white capital letters
- Border - Reflective white

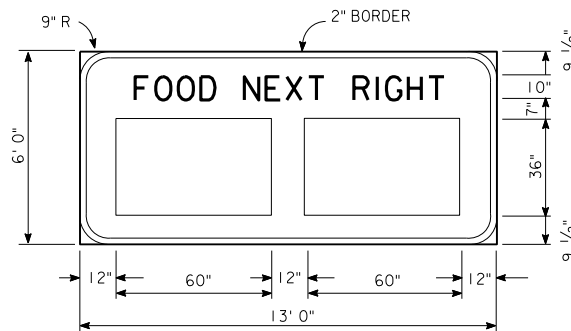

PANEL B-1

- NOTES:
1. Panel B is intended for usage where there are at least 2 qualified services and the possibility for more.
 2. Panel B-1 may be used where there is only 1 qualified service and it is not likely that there will be more than 2.
 3. All reflective sheeting shall be ASTM D4956 Type IV or greater.
 4. Exit number shall be displayed at numbered interchanges, in place of directional legend, (see illustration 4).

SPECIFIC INFORMATIONAL SIGN SIZE ALTERNATES
(SINGLE EXIT INTERCHANGE)

Illustration 6

Sign Details: Panel Color-Reflective blue; Message-10" reflective white capital letters
Border -reflective white.

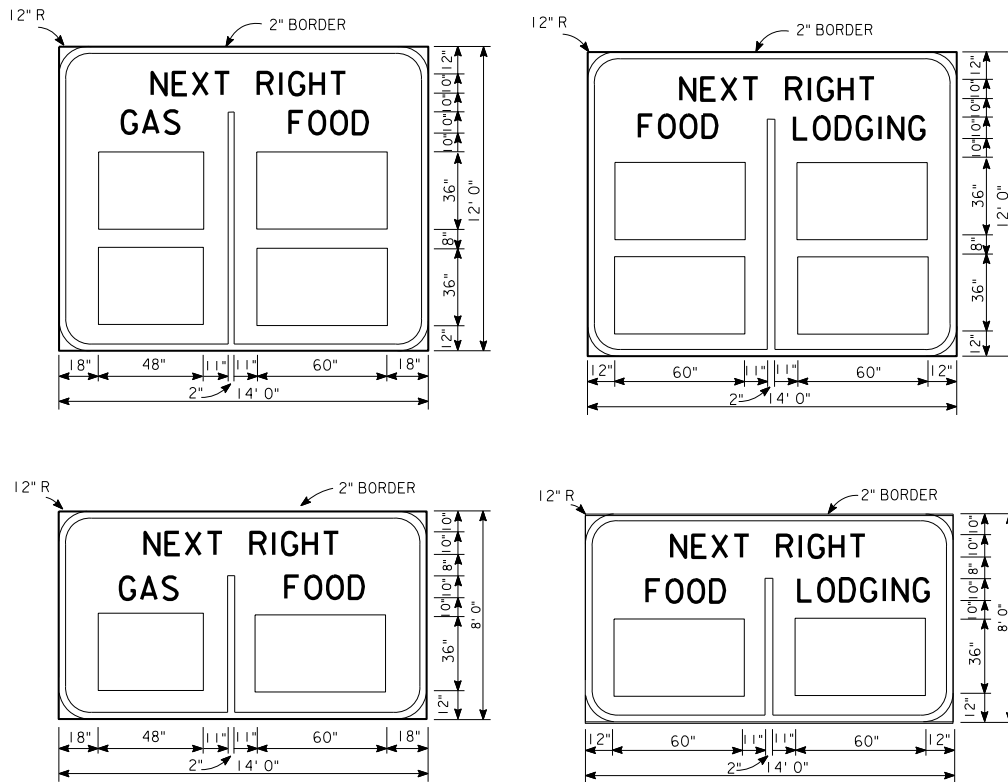

- NOTES:
1. These alternate panels may be used where there are a limited number of services in remote rural areas.
 2. Exit numbers shall be displayed at numbered interchanges in place of directional legend, (see illustration 4).

SPECIFIC INFORMATIONAL SIGN SIZES
(DOUBLE EXIT INTERCHANGE)

Illustration 7

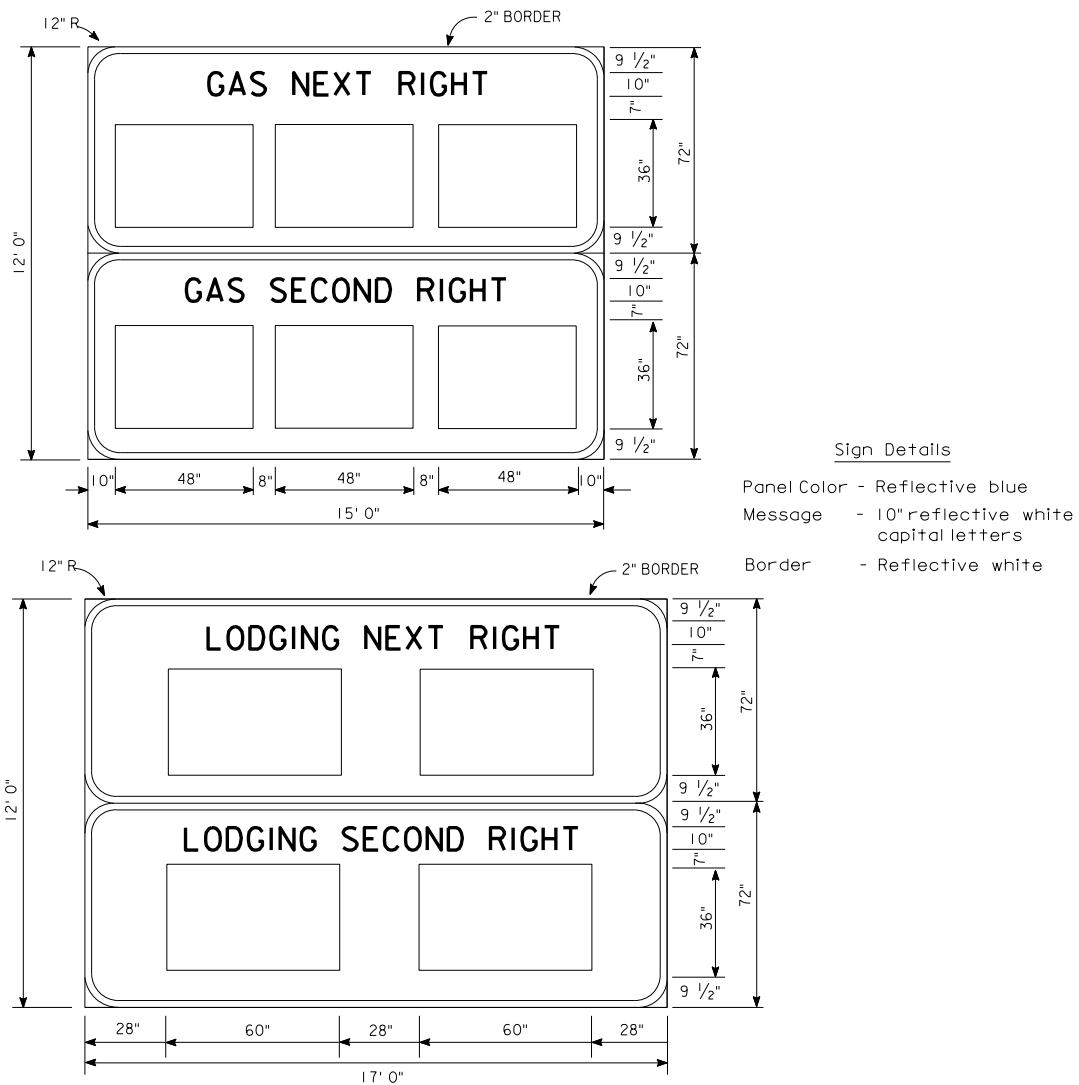

- NOTES:
- Exit numbers shall be displayed at numbered interchanges, (see illustration 4).
 - All reflective sheeting shall be ASTM D4956 Type IV or greater.

SUPPLEMENTAL DIRECTIONAL SIGN SIZES
(RAMP)

Illustration 8

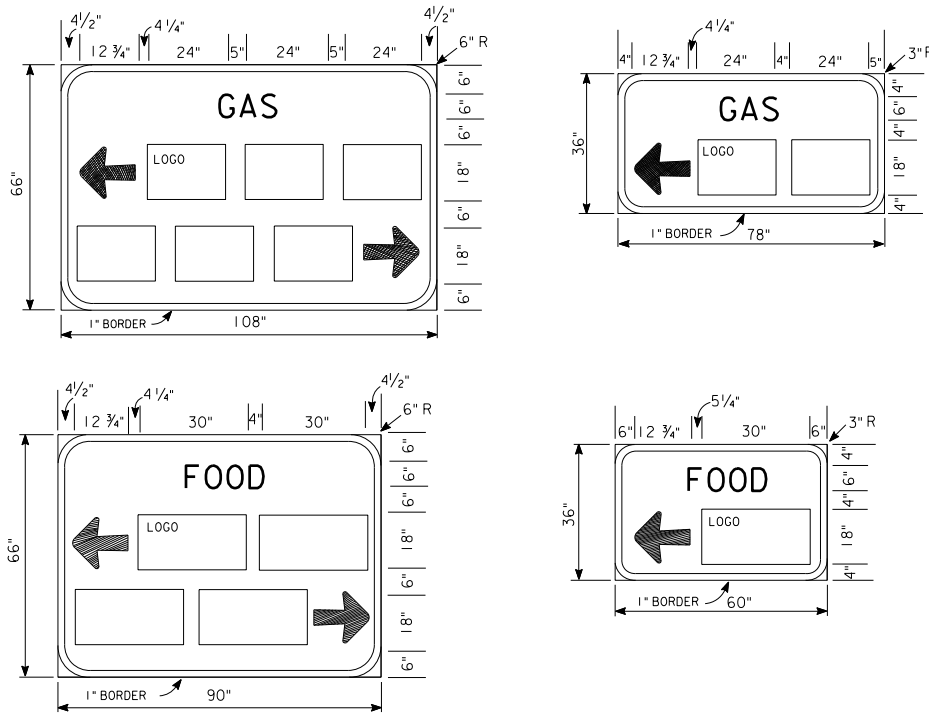

4 1/2"

Mileage Plate

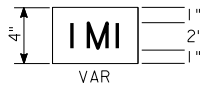

May be used under business sign where business is not visible from off-ramp.

- Plate Color - Reflective blue, no border
 I MI - 2" white caps (w/reflective sheeting)
 - Show mileage to nearest 1/4 mile

Sign Details

- Panel Color - Reflective blue
 Message - 6" reflective white capital letters
 Border - 1" white reflective
 Arrows - Standard arrow for 6" caps
 Corner Radius - As shown

- NOTES: 1. Appropriate size signs may be selected depending on the number of businesses.
 2. The position and direction of arrows may be varied as required.
 3. All reflective sheeting shall be ASTM D4956 Type IV or greater.

ALTERNATE SUPPLEMENTAL DIRECTIONAL SIGNS
MORE THAN 1/2 MAXIMUM NUMBER OF BUSINESSES IN ONE DIRECTION

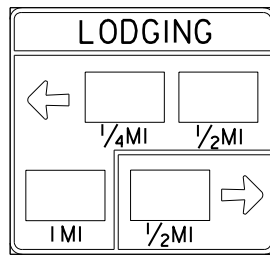
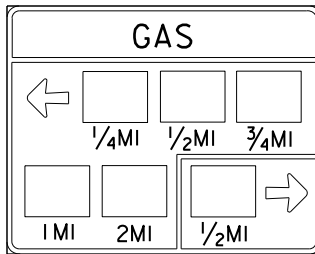

RAMP

Illustration 10

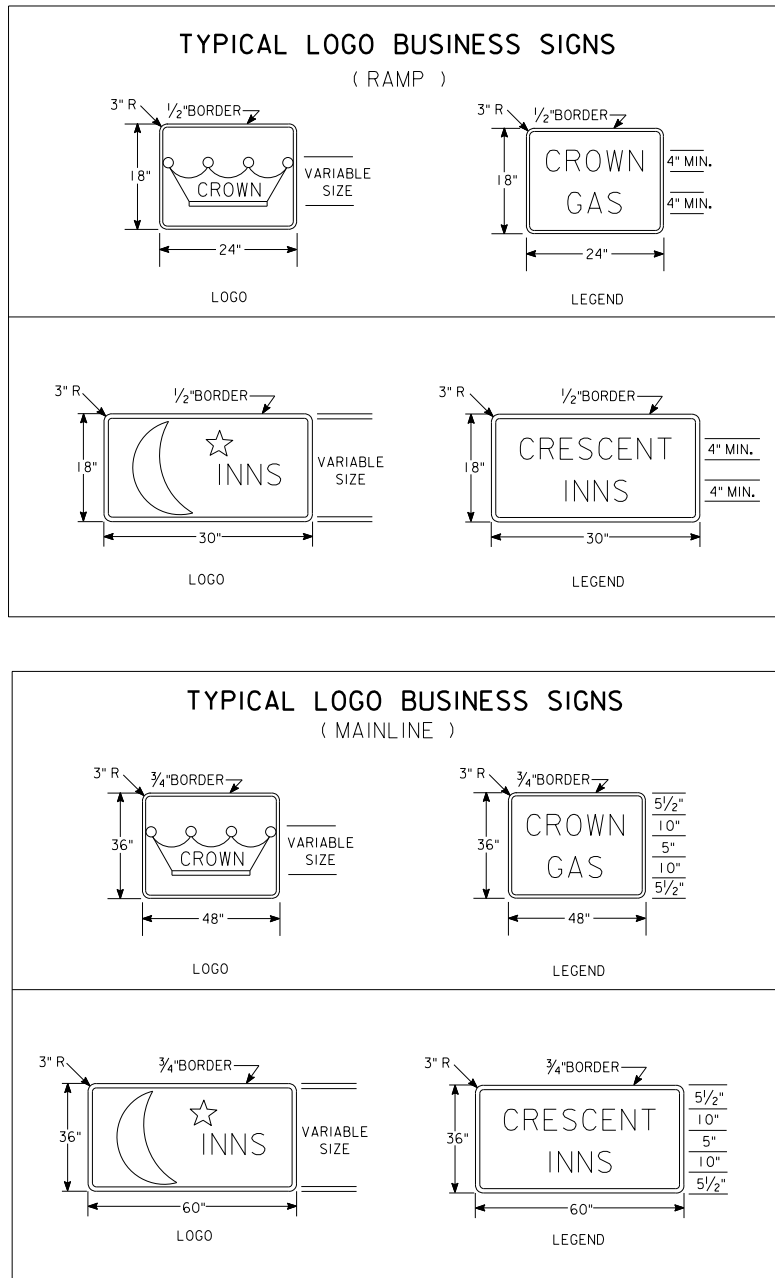
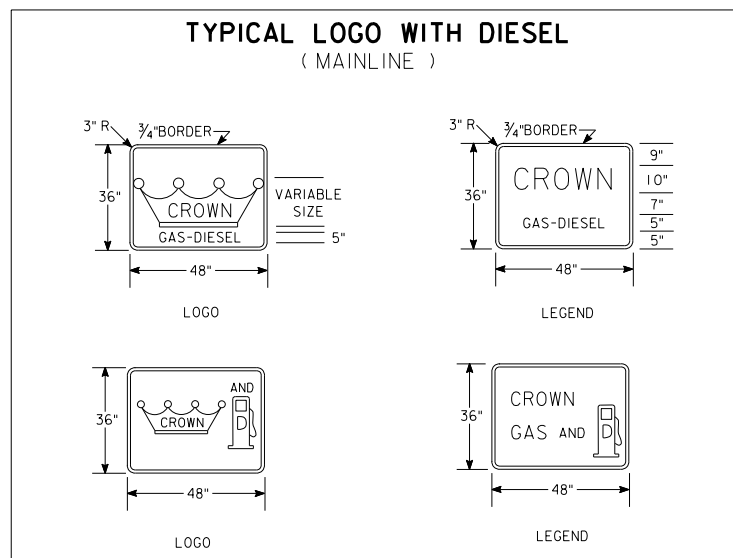
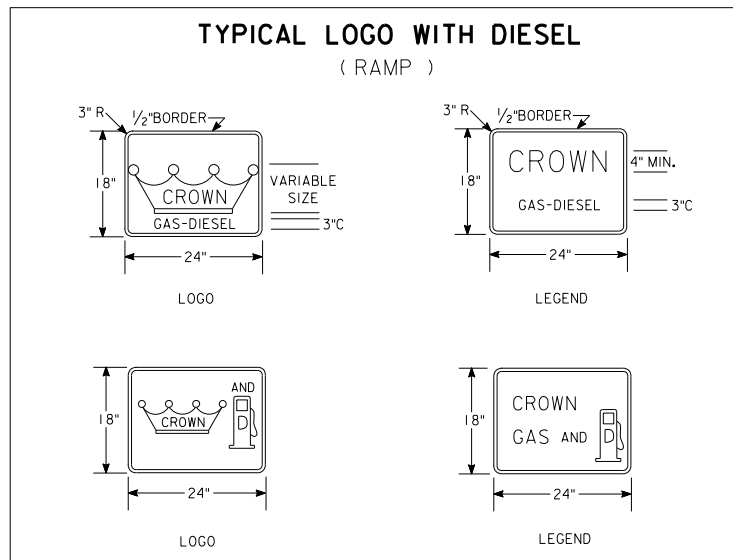

Illustration 11



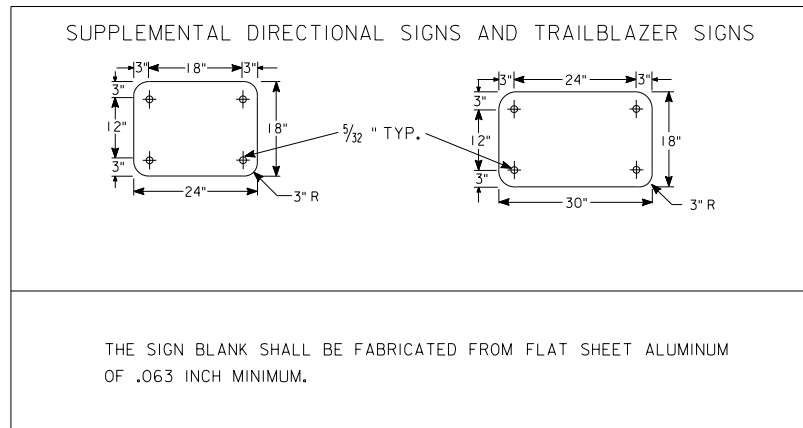
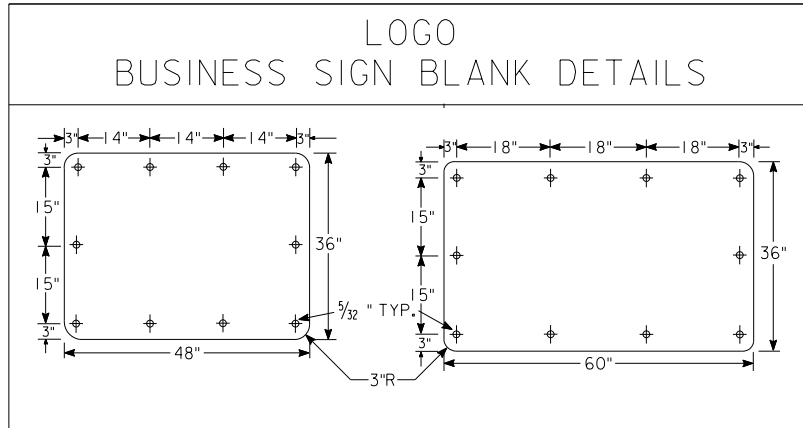
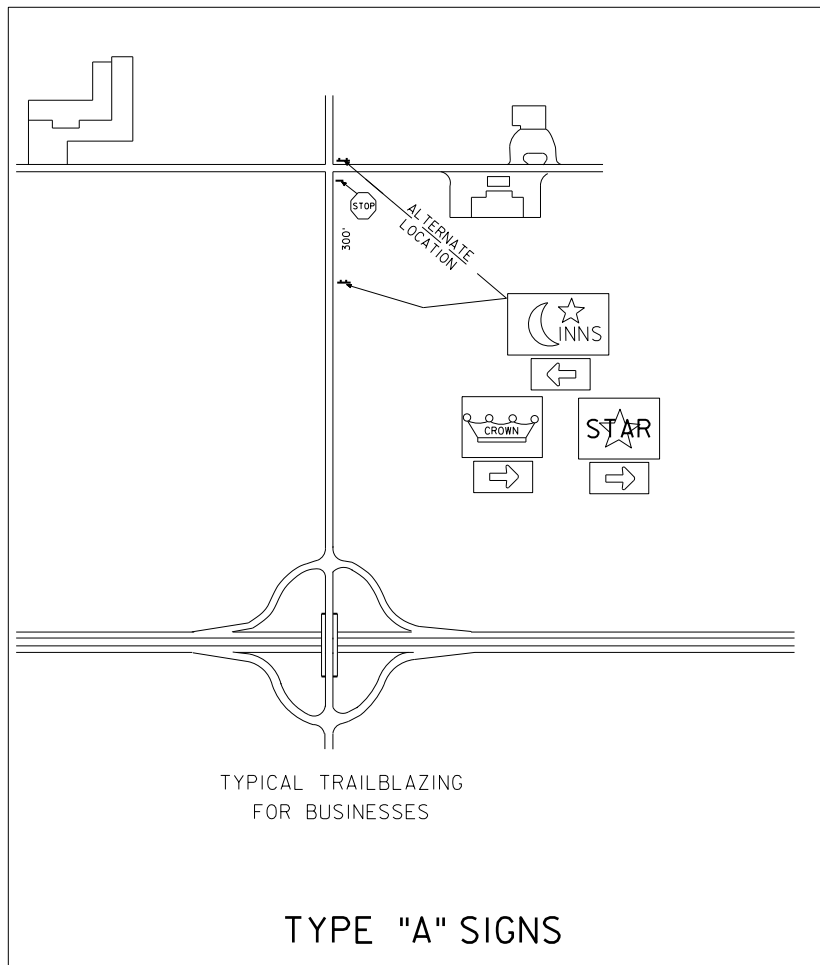

Illustration 13



TRAILBLAZER SIGNS WILL BE CONSTRUCTED OF 0.063 ALUMINUM WITH AN ARROW PANEL UNDERNEATH. (SIMILAR TO STATE AND FEDERAL ROUTE MARKERS)

SIGNS MAY BE INSTALLED ON 4X6 WOOD POSTS, 4X4 WOOD POSTS, STEEL U-POST, PIPE POST, OR ALUMINUM TYPE X POST.

Chapter 4 - Specific Informational and Business (Logo) Signs (Continued)

BREAK-AWAY TYPE WOOD POST DETAILS

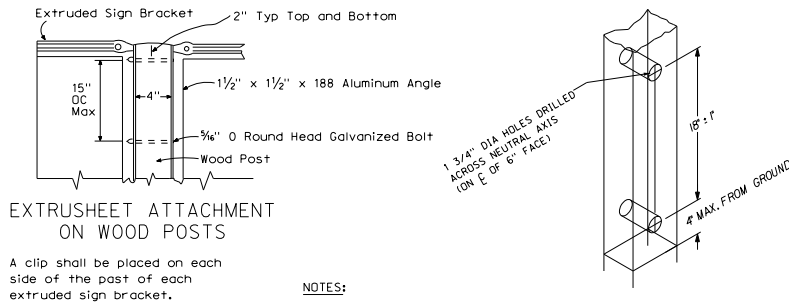

EXTRUSHEET ATTACHMENT ON WOOD POSTS

A clip shall be placed on each side of the post of each extruded sign bracket.

NOTES:

- (1) 6" x 4" Posts shall be drilled for Break-Away.
- (2) 4" x 4" Posts do not need to be drilled for Break-Away.
- (3) Minimum Depth of Posts Shall be 36".
- (4) Ground to Be Firmly Tamped.

BREAK-AWAY TYPE STEEL POST DETAILS

NOTES:

1. BREAK-AWAY DEVICE SHALL BE FEDERALLY APPROVED.
2. POST DEPTH IS MINIMUM 36".

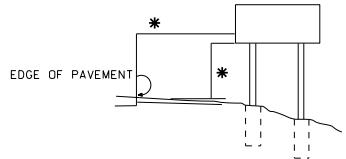
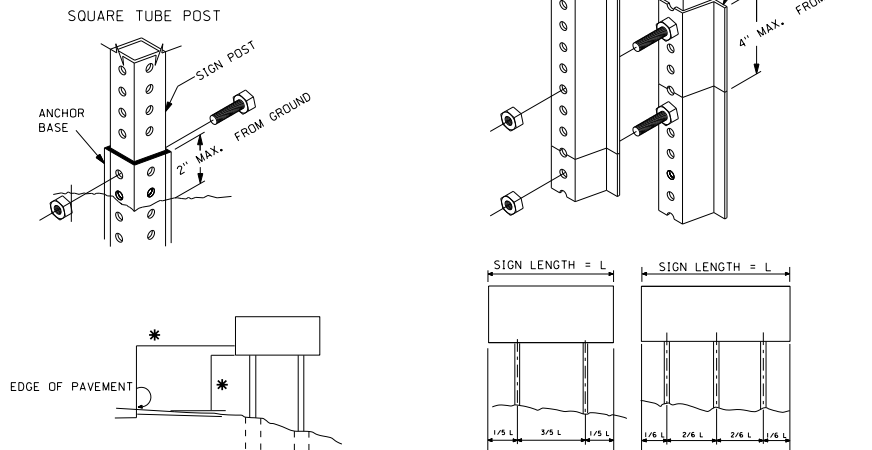

* 12' FROM PAVEMENT EDGE AND 7' ABOVE PAVEMENT EDGE WHERE A SIGN IS TO BE MOUNTED ON WOOD POSTS.

SIGNS LOCATED ADJACENT TO ROADWAY

TRAIL BLAZER
BUSINESS (LOGO) SIGNS
EXHIBIT A
BREAK-AWAY TYPE POST
DETAILS FOR TYPE "A" SIGNS

Title 411- NEBRASKA DEPARTMENT OF ROADS - TRAFFIC ENGINEERING DIVISION

Chapter 4 - Specific Informational and Business (Logo) Signs (Continued)

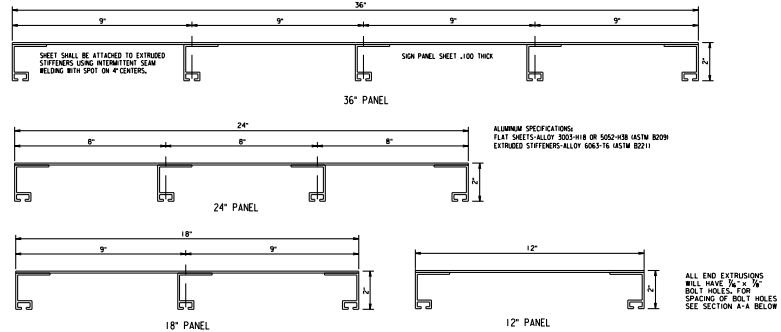

EXTRUSHEET PANEL WIDTHS
 (MOLDED EXTRUDED PANELS MAY BE SUBMITTED
 AS AN ALTERNATE TO EXTRUSHEET PANELS)

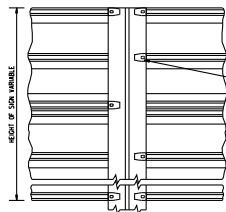

TYPICAL MOUNTING FOR EXTRUSHEET SIGN PANEL

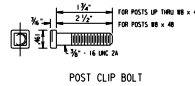

POST CLIP BOLT

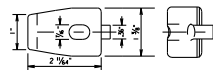

POST CLIP

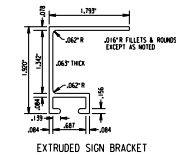
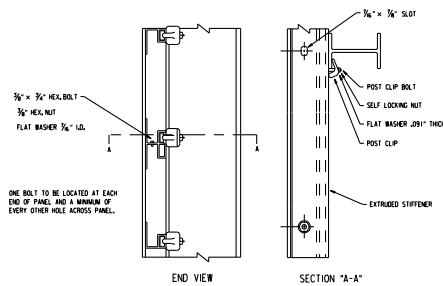

EXTRUDED SIGN BRACKET

* POSTS CLIPS SHALL BE ALUMINUM ALLOY 356.0 CONFORMING TO ASTM B 208 FOR POST CLIPS AND SIGN BRACKET BOLTS SHALL BE ALUMINUM ALLOY 2024-T4 CONFORMING TO ASTM B 211 LOCKWASHERS FOR ALUMINUM BOLTS SHALL BE ALUMINUM ALLOY 2017-T4 CONFORMING TO ASTM B 211.

SPECIFIC INFORMATIONAL AND BUSINESS (LOGO) SIGNS
 EXHIBIT B
 TYPE "B" SIGN PANELS
 FABRICATION & MOUNTING DETAILS

Chapter 4 - Specific Informational and Business (Logo) Signs (Continued)

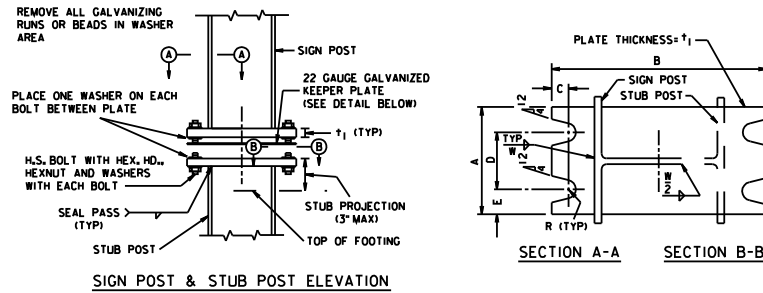

STUB POST BASE CONNECTION TABLE												
SIGN AREA SQ. FT.	POST NO.	W SHAPES	BOLT SIZE, LENGTH & MAX. TORQUE	A	B	C	D	E	T ₁	W	R	# CONNECTION WT. IN LBS.
0-85	I	W6 x 15	3/4" x 3-1/4"	6	10 1/4	3/4"	3 1/2	1 1/4	1	5/16	13/32	88
86-120	II	W8 x 18	80 FT.-LB.	6	12 1/2	3/4"	3 1/2	1 1/4	1	5/16	13/32	105
121-170	III	W8 x 24	7/8" x 4"	8	13 1/4	7/8"	4	2	1 1/4	3/8	15/32	164
171-225	IV	W8 x 31	100 FT.-LB.	8	13 1/4	7/8"	4	2	1 1/4	3/8	15/32	184
OVER 225	V	W8 x 48		8	13 3/4	7/8"	4	2	1 1/4	3/8	15/32	238

* INCLUDES WEIGHTS OF 2 BASE CONNECTION PLATES, BOLTS, WASHERS, STUB POST, FUSE PLATE AND WELDING. WEIGHT OF POST, ABOVE BASE CONNECTION, SHALL BE COMPUTED AND ADDED FOR EACH LOCATION.

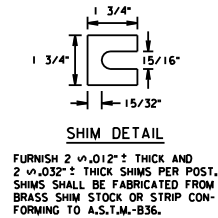

FURNISH 2 $\pm .012$ " THICK AND 2 $\pm .032$ " THICK SHIMS PER POST. SHIMS SHALL BE FABRICATED FROM BRASS SHIM STOCK OR STRIP CONFORMING TO A.S.T.M.-B36.

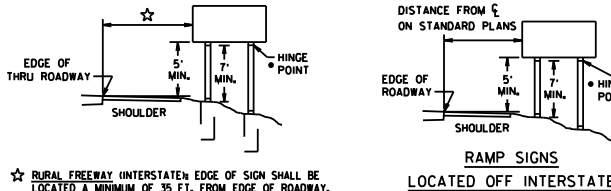
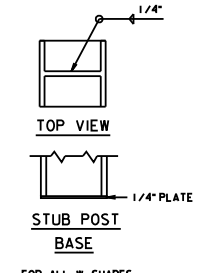
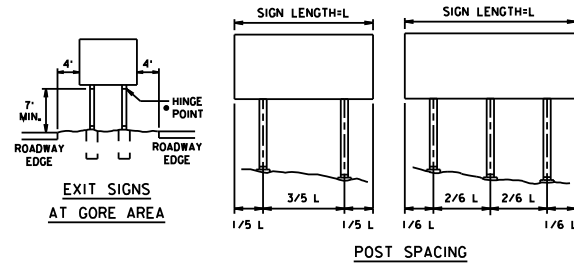

☆ RURAL FREEWAY (INTERSTATE) EDGE OF SIGN SHALL BE LOCATED A MINIMUM OF 35 FT. FROM EDGE OF ROADWAY.
 RURAL EXPRESSWAY: EDGE OF SIGN SHALL BE LOCATED A MINIMUM OF 30 FT. FROM EDGE OF ROADWAY.
 URBAN FREEWAY (INTERSTATE) OR EXPRESSWAY: EDGE OF SIGN SHALL BE LOCATED A MINIMUM OF 30 FT. FROM EDGE OF THRU ROADWAY.

SIGNS LOCATED ADJACENT TO ROADWAY

* THE HINGE POINT SHOULD BE AT LEAST 7 FEET ABOVE THE GROUND
 NO SUPPLEMENTARY SIGN SHALL BE PLACED BELOW THE HINGES

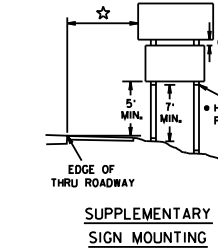

SUPPLEMENTARY SIGN MOUNTING

NEBRASKA DEPARTMENT OF ROADS
 TRAFFIC ENGINEERING DIVISION
 EXHIBIT C 1 of 2
 BREAK-AWAY TYPE POST
 DETAILS FOR TYPE 'B' SIGNS

Chapter 4 - Specific Informational and Business (Logo) Signs (Continued)

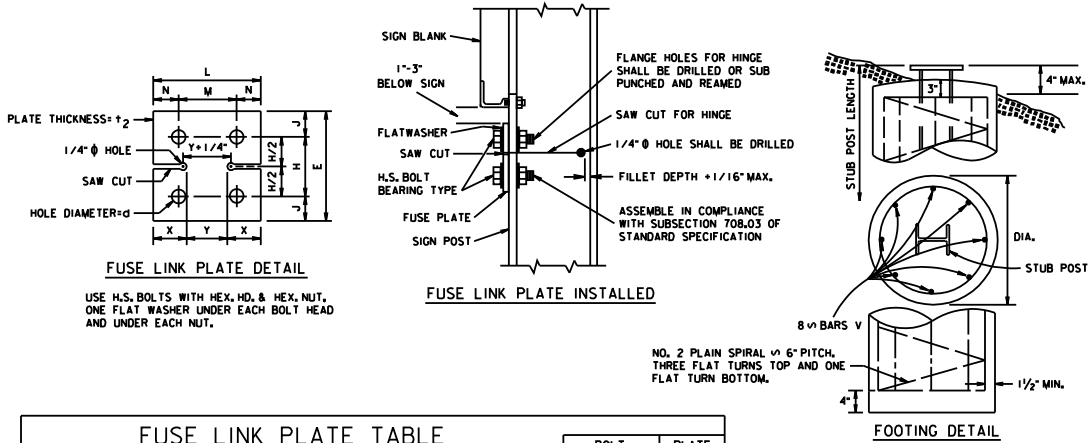

POST NO.	E	H	J	L	M	N	X	Y	d	t	BOLT		PLATE
											DIA.	MIN. LENGTH	wt. In lbs.
I	5 1/4	2 3/4	1 1/4	5	2 3/4	1 1/8	2 1/16	7/8	11/16	3/8	5/8	2 1/4	2.54
II	5 1/4	2 3/4	1 1/4	5	2 3/4	1 1/8	2 1/16	7/8	11/16	3/8	5/8	2 1/4	2.54
III	6 1/2	3 1/2	1 1/2	6 1/2	3 1/2	1 1/2	2	2 1/2	15/16	1/2	7/8	2 3/4	5.63
IV	6 1/2	3 1/2	1 1/2	6 1/2	3 1/2	1 1/2	2	2 1/2	15/16	1/2	7/8	3	5.63
V	6 1/2	3 1/2	1 1/2	6 1/2	3 1/2	1 1/2	2	2 1/2	15/16	1/2	7/8	3	5.63

IF MINIMUM BOLT LENGTHS AS SHOWN IN TABLE ARE NOT AVAILABLE, USE NEXT LONGER STANDARD BOLT LENGTH.

BOLT SIZE	REQUIRED MIN. BOLT TENSION (lbs.)	EQUIVALENT TENSION
1/2	12,050	*
3/8	19,200	*
3/4	28,400	*
7/8	39,250	*
1	51,500	*

* SEE NOTE 9

PROCEDURE FOR ASSEMBLY OF BASE CONNECTION

- ASSEMBLE POST TO STUB WITH BOLTS, WITH ONE FLAT WASHER ON EACH BOLT BETWEEN PLATES.
- SHIM AS REQUIRED TO PLUMB POST.
- TIGHTEN ALL BOLTS THE MAXIMUM POSSIBLE WITH 12" TO 15" WRENCH TO BED WASHERS AND SHIMS AND TO CLEAN BOLT THREADS THEN LOOSEN EACH BOLT IN TURN AND RETIGHTEN IN A SYSTEMATIC ORDER. THIS PROCEDURE SHALL BE REPEATED UNTIL ALL BOLTS HAVE BEEN PROPERLY TENSIONED BY THE TURN-OF-NUT METHOD (SEE NOTE 9).
- BURR THREAD AT JUNCTION WITH NUT, USING A CENTER PUNCH TO PREVENT NUT LOOSENING.

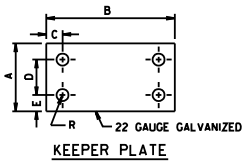

NOTE: SEE STUB POST BASE CONNECTION TABLE FOR DIMENSIONS.

ALL TABLE DIMENSIONS IN INCHES EXCEPT AS INDICATED.

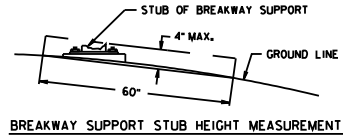

GENERAL NOTES

- THE FABRICATION OF THE SUPPORTS INVOLVING SUCH OPERATIONS AS CUTTING, DRILLING, BENDING AND CLEANING SHALL BE IN ACCORDANCE WITH SECTION 708.03. MILL TEST REPORTS SHALL BE SUBMITTED TO THE ENGINEER PRIOR TO FABRICATION.
- SIGNS SHALL BE ERECTED SO THE SIGN FACE IS TRULY VERTICAL AND AT A 93° ANGLE (AS SHOWN) WHEN THE SIGN IS 15' OR LESS FROM THE EDGE OF THE PAVEMENT. WHEN THE SIGN IS MORE THAN 15' FROM THE PAVEMENT EDGE, THE SIGN SHOULD BE PLACED NOT LESS THAN 90° TO THE DIRECTION OF TRAFFIC.
- THE FOOTINGS ARE DESIGNED IN CYLINDRICAL SHAPE FOR USE WITH POWER EQUIPMENT, WHERE CONDITIONS PERMIT. CONCRETE MAY BE POURED AGAINST SOIL WITHOUT FORMING, EXCEPT FROM A MINIMUM OF 6" UNDER EXPOSED LOW SIDE (AS SHOWN TO THE TOP OF THE FOOTING).
- ALL CONCRETE SHALL BE CLASS "4B".
- ALL STRUCTURAL STEEL SHALL COMPLY WITH ASTM-A36 OR EQUAL AND SHALL BE GALVANIZED IN ACCORDANCE WITH ASTM-A123.
- ALL BOLTS, NUTS AND WASHERS SHALL BE GALVANIZED HIGH STRENGTH STEEL COMPLYING WITH ASTM-A325.
- THE SAW CUT FOR THE HINGE SHOULD BE MADE ON THE JOB SITE TO AVOID DEFORMATION OF THE PRE-CUT POST IN SHIPPING. IF THE CONTRACTOR ELECTS TO SAW CUT FOR THE HINGE BEFORE GALVANIZING THE POST, THE POST SHALL BE CAREFULLY INSPECTED AT THE JOB SITE AND ANY DEFORMATION OF THE POST SHALL BE CAUSE OF REJECTING THE POST. IF THE SAW CUT IS FILLED WITH GALVANIZING MATERIAL ON ARRIVAL AT THE JOB SITE, THE CONTRACTOR SHALL BE REQUIRED TO REMOVE THE GALVANIZING FROM THE CUT. WHEN THE SAW CUT IS MADE AT THE JOB SITE, THE SAW CUT SHALL BE TREATED WITH A ZINC DUST-OXIDE PRIMER OR ZINC RICH PAINT COMPLYING WITH SECTION 1077.
- ALL POSTS WITHIN A 7-FOOT PATH SHOULD NOT WEIGH MORE THAN 45 POUNDS PER FOOT AND THE TOTAL WEIGHT BELOW THE HINGE, BUT ABOVE THE SHEAR PLATE OF THE BREAKAWAY BASE, SHOULD NOT EXCEED 600 POUNDS.
- FUSE PLATE BOLTS MUST BE TIGHTENED BY THE TURN-OF-NUT METHOD. SEE TABLE 708.04 FOR PROPER NUT ROTATION. ASSEMBLE IN COMPLIANCE WITH SUBSECTION 708.03.
- SIGN POSTS SHALL BE CUT OFF FLUSH WITH THE TOP OF THE SIGN.

POST NO.	STUB POST LENGTH	STUB POST PROJECTION	DIA.	DEPTH	CUB. YDS. OF CONC.	VERTICAL REBAR SIZE
I	3'-0"	3"	24"	4'-6"	.52	#4
II	3'-0"	3"	30"	4'-6"	.82	#4
III	3'-0"	3"	30"	5'-0"	.91	#5
IV	3'-0"	3"	36"	5'-6"	1.44	#5
V	3'-0"	3"	36"	5'-6"	1.44	#5

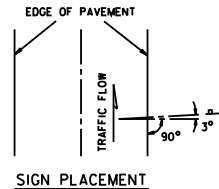

NEBRASKA DEPARTMENT OF ROADS
TRAFFIC ENGINEERING DIVISION

EXHIBIT C 2 of 2
BREAK-AWAY TYPE POST
DETAILS FOR TYPE 'B' SIGNS

